

Inhalt/Contents

Wandhalter/*Brackets*

MacFOX	4
XFOX	5
TwinFOX	6

Befestigungen für Holz/*Fixing for laths*

MacWUDI, MacUNI	7
-----------------------	---

Profile/*Profiles*

Standard Profile/ <i>Standard-Profiles</i>	8
Fugen-/Eckprofile/ <i>Joint-/Corner-Profiles</i>	9
Hut-/Z-Profile/Stoßverbinder/ <i>Omega-/Z-Profiles/Connection-Piece</i>	10
F-/Z-Profile/Stoßverbinder/ <i>F-/Z-Profiles/Connection-Piece</i>	11
Sonderprofile/ <i>Special-Profiles</i>	12 – 13

Zubehör/*Accessories*

Verbindungs- und Befestigungsmittel/ <i>Fasteners and Screws</i>	14
Befestigungsmittel/Klebesystem/ <i>Fasteners/Adhesive System</i>	15
Isolatoren/ <i>Insulators</i>	16
Confox/Disfox	17

System-Profile/*Special-System-Profiles*

MTC-v-100	18
XLC-h-320	19
MTC-v-200	20
XLC-h-330	21
MTC-v-350	22
XLC-h-350	23

MLV/k-v-20	24
MLZ/k-v-00	25
XLP-v-300	26
XTS-v-400	27
XLS-h-330	28
XLP-v-400	29
XTS-v-300	30
XLS-h-300	31
XLT-v-100/XLT-v-200	32
Authan/Shamal	33
MUK-v-a-100	34
MTA-v-400/MYA-v-900	35

MacFOX

Distanzhalter/Bracket

Werkstoff/Material: Al Mg Si 0,5/F25

MacFOX Medium

Festpunkt/Gleitpunkt

Fixpoint/Flexible point

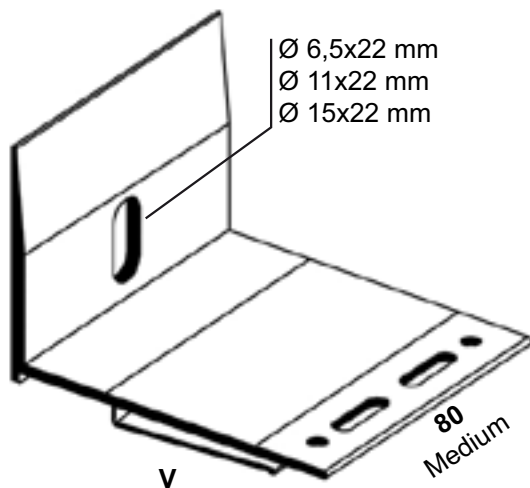

V	Code
40	17/40M-11
60	17/60M-11
90	17/90M-11
120	17/120M-11
150	17/150M-11
180	17/180M-11
210	17/210M-11
240	17/240M-11

MacFOX Large

Festpunkt/Gleitpunkt

Fixpoint/Flexible point

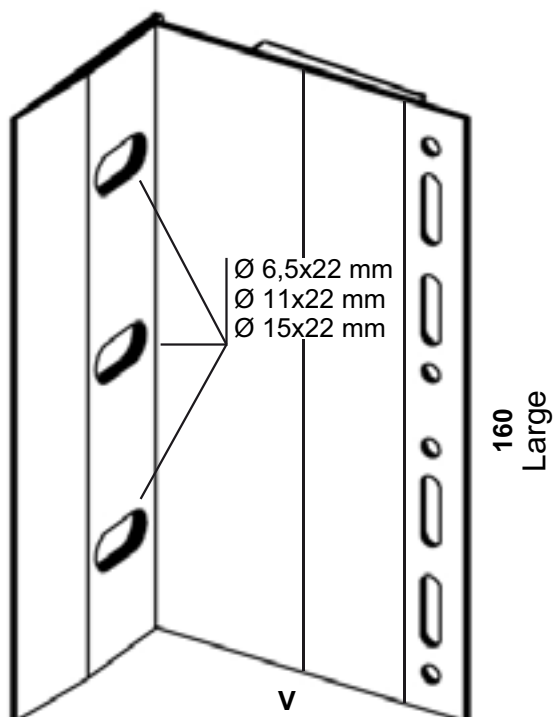

V	Code
40	17/40L-11
60	17/60L-11
90	17/90L-11
120	17/120L-11
150	17/150L-11
180	17/180L-11
210	17/210L-11
240	17/240L-11



Artikelliste/Partlist

XFOX

Distanzhalter/Bracket

Werkstoff/Material: Al Mg Si 0,5/F22

XFOX Medium

Festpunkt/Gleitpunkt

Fixpoint/Flexible point

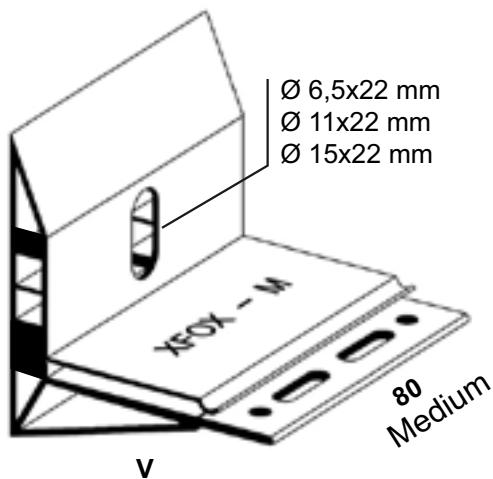

V	Code
70	17/X70M-11
90	17/X90M-11
120	17/X120M-11
150	17/X150M-11
180	17/X180M-11

XFOX Large

Festpunkt/Gleitpunkt

Fixpoint/Flexible point

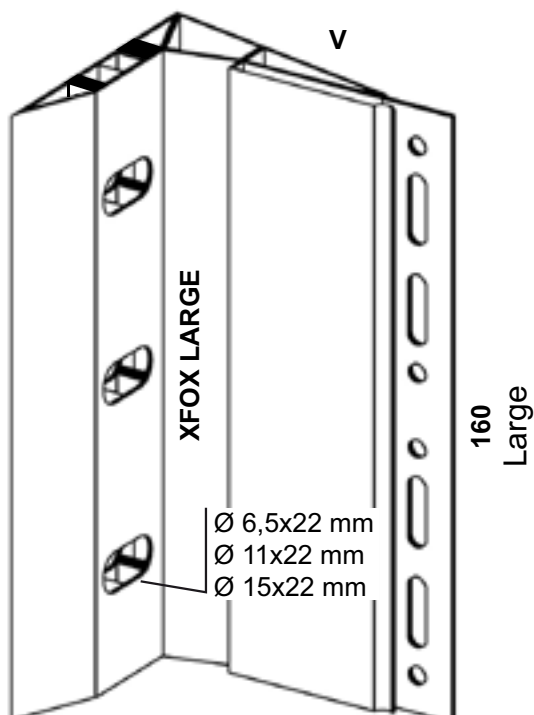

V	Code
70	17/X70L-11
90	17/X90L-11
120	17/X120L-11
150	17/X150L-11
180	17/X180L-11



www.eurofox.com

Artikelliste/Partlist

TwinFOX

Distanzhalter/Bracket

Werkstoff/Material: Al Mg Si 0,5/F22

TwinFOX Medium

Festpunkt/Gleitpunkt

Fixpoint/Flexible point

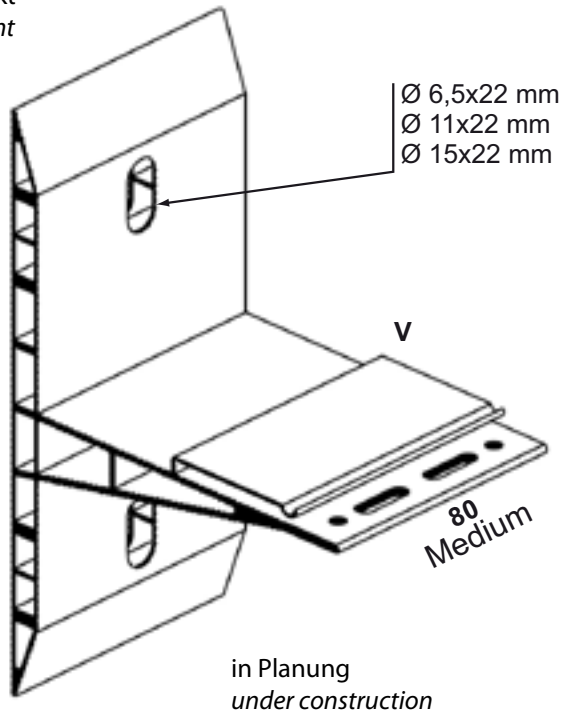

Code
19/TF70M-11
19/TF90M-11
19/TF120M-11
19/TF150M-11
19/TF180M-11
19/TF210M-11

TwinFOX Large

Festpunkt/Gleitpunkt

Fixpoint/Flexible point

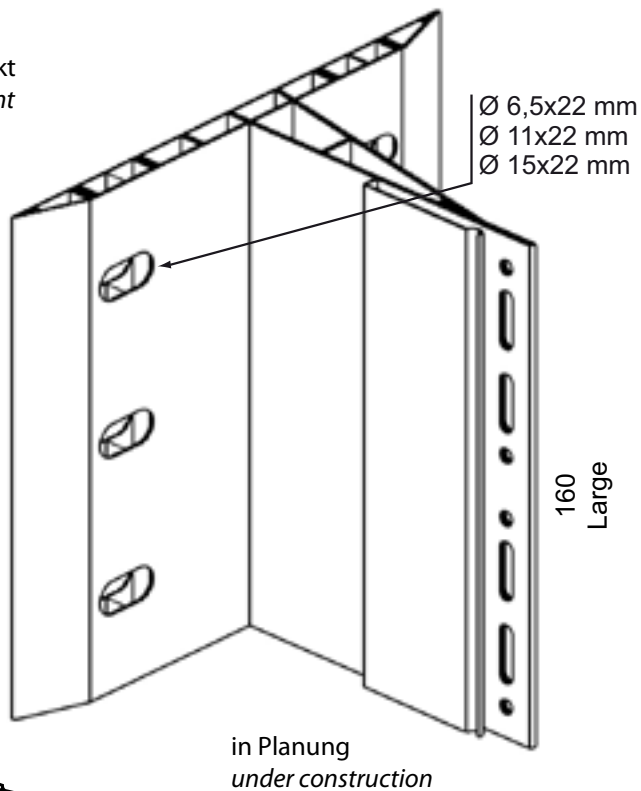

Code
19/TF70L-11
19/TF90L-11
19/TF120L-11
19/TF150L-11
19/TF180L-11
19/TF210L-11



Artikelliste/Partlist

MacWUDI/MacUNI

Werkstoff/Material: Al Mg Si 0,5/F25

MacWUDI

Ausladung (V)/Min. distance: 70/100 mm

Öffnungsmaß (W)/Opening width: 50/60 mm

Breite/Width: 80 mm

Nr. M 806/S4583/M 783

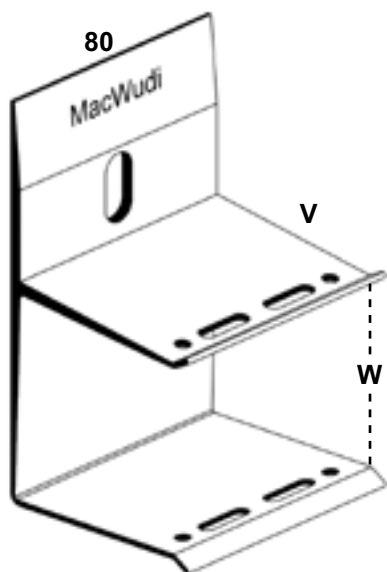

W/V/X	Code
50/70/80	08/MW50/70 M
50/100/80	08/MW50/100 M
60/70/80	08/MW60/70 M

MacUNI

Für Holzlatzen und Kassettenprofile

For laths and cassette-profiles

Höhe (H)/Height: 80/160 mm

Breite (W)/Width: 60/80 mm

Nr. S5454 - 887/S5453 - 801

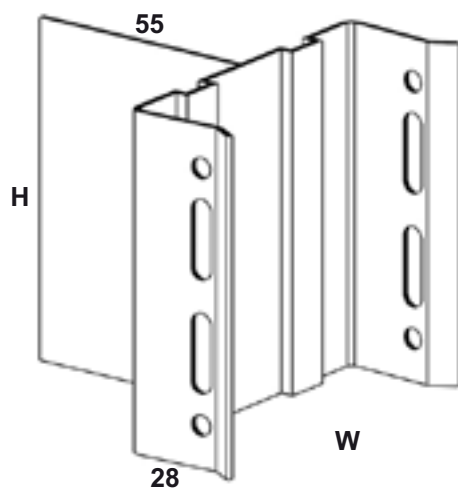

W/H	Code
60/80	03/060 M
60/160	03/060/160 M
80/80	03/080 M
80/160	03/080/160 M



www.eurofox.com

Standard Profile/Standard Profiles

Werkstoff/Material: Al Mg Si 0,5/F25, Länge/Fixlength 6000mm

L-Profil 60/40

Dicke 1,8 - 2,2 mm

L-Profile 60/40

Thickness 1,8 - 2,2 mm

Nr. S3503 - 398

Nr. S5371 - 483

Nr. S4716 - 504

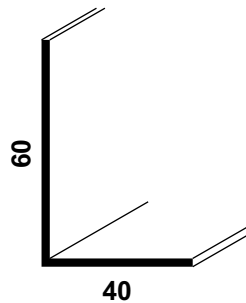

T-Profil 60/60

Dicke 1,8 mm

T-Profile 60/60

Thickness 1,8 mm

Nr. S5301 - 486

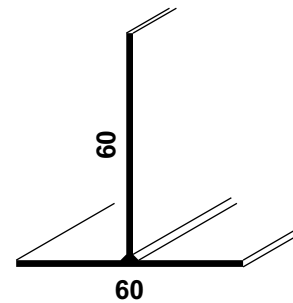

Code

05/L60/40/1,8

05/L60/40/2N

05/L60/40/2,2N

Code

05/T60/60/1,8N

T-Profil 60/80

Dicke 1,8 mm

T-Profile 60/80

Thickness 1,8 mm

Nr. S3502 - 570

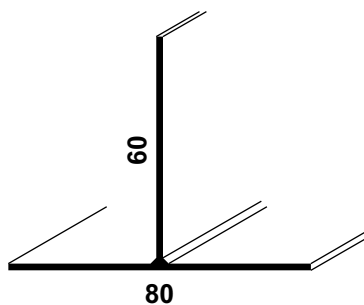

T-Profil 60/100

Dicke 1,8 - 2,1 mm

T-Profile 60/100

Thickness 1,8 - 2,1 mm

Nr. S3502 - 570

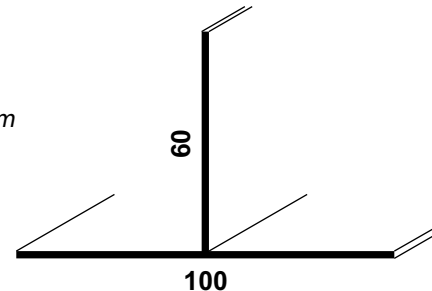

Code

05/T80/60/1,8N

Code

05/T60/100/1,8N

05/T60/100/2N

05/T60/100/2,1

T-Profile 60/120

Dicke 1,9/2,0 mm

T-Profile 60/120

Thickness 1,9/2,0 mm

Nr. S4801 - 779

Nr. S5384 - 879

Nr. 101006551 - 810

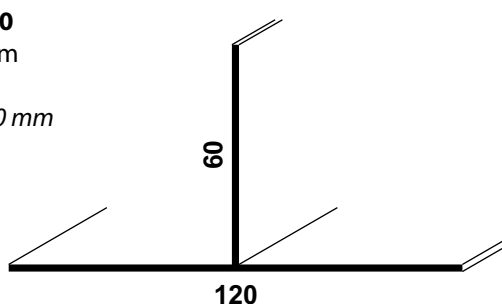

T-Profile 60/140

Dicke 2,0/2,2 mm

T-Profile 60/140

Thickness 2,0/2,2 mm

Nr. S1996 - 922

Nr. S6143 - 1072

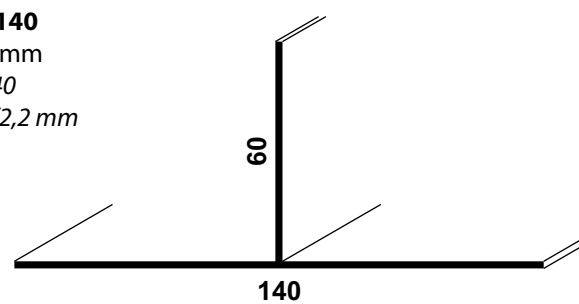

Code

05/T60/120/1,9N

05/T60/120/2N

05/T60/120/2MC

Code

05/T60/140/2N

05/T60/140/2,2N



Fugen-/Eckprofile/Joint-/Corner-Profiles

Werkstoff/Material: Alu/PVC

Fugenprofil vertikal, schwarz beschichtet
Joint-Profile vertical, black coated

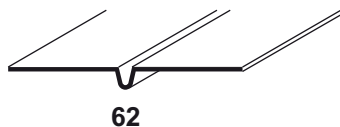

Code
20/9042

Fugenprofil horizontal
Joint-Profile horizontal

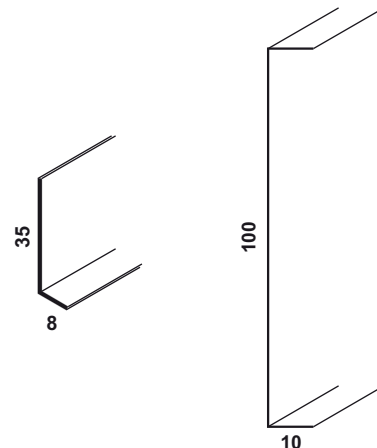

Code
20/9092
20/FB10/100

Fugenprofil horizontal
Joint-Profile horizontal

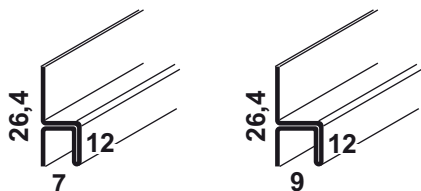

Code
20/9061
20/9062

Lüftungsprofil Alu 70x30 mm
Lüftungsprofil Alu 100x40 mm
Ventilation-Profile

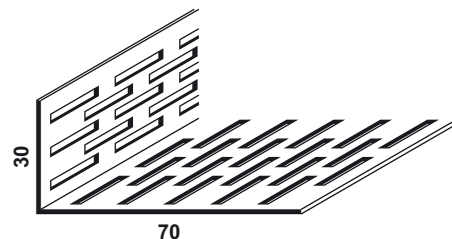

Code
20/9044
20/9045

Fugenband Kunststoff 36 & 100 mm schwarz
Joint-Strip black

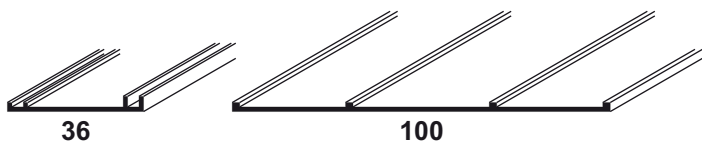

Code
20/3331
20/3334

Kantenprofil 48,8x48,8x1,2 mm
Alu-Corner-Profile

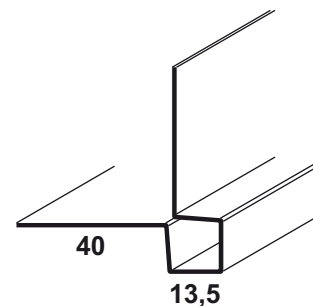

Code
20/9080



Hut-/Z-Profil/Stoßverbinder/Omega-/Z-Profiles/Connection-Piece

Werkstoff/Material: Al Mg Si 0,5/F25, Länge/Fixlength 6000mm

Hutprofil 40/29,8

Hatprofile
Nr. S 5187 - 792

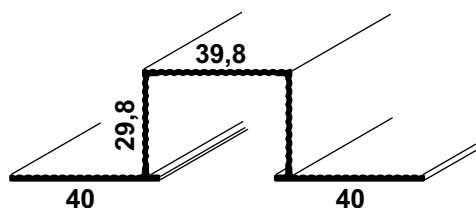

Code

05/Hut40/29,8

Hutprofil für Klebtechnik

Hatprofile for adhesive system
Nr. S5504 - 659

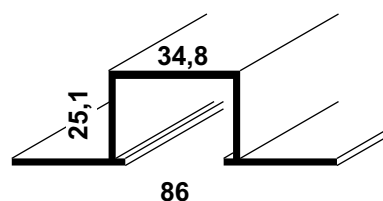

Code

05/Hut86/25N

Z-Profil 40/29,8

Z-Profile 40/29,8
Nr. S 5188 - 541

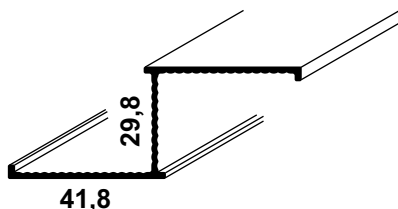

Code

05/Z40/29,8

Hutprofil für Klebtechnik (Randbereich)

Hatprofile for adhesive system (corner section)
Nr. S5505 - 535

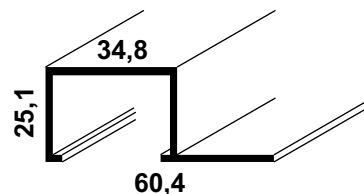

Code

05/Hut60/25N

U-Profil 25/35/2 (Stoßverbinder)

U-Profile 25/35/2 (Connection-Piece)
Nr. 0 - 440

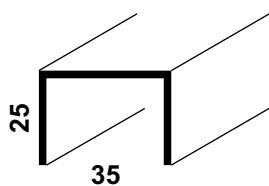

Code

05/U25/35/2 MC

U-Profil 20/30/2 (Stoßverbinder)

U-Profile 20/30/2 (Connection-Piece)
Nr. 0 - 356

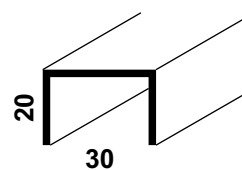

Code

05/U20/30/2 MC



F-/Z-Profil/Stoßverbinder/F-/Z-Profiles/Connection-Piece

Werkstoff/Material: Al Mg Si 0,5/F25, Länge/Fixlength 6000mm

Z-Profil 56/25

Z-Profile 56/25

System MLZ-v-500
Nr. 0 - 335

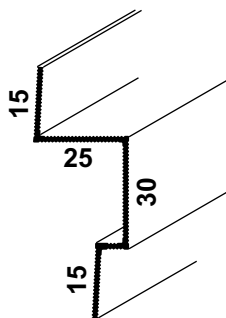

Code

05/Z56/25

L-Profil 25/35/3 (Stoßverbinder)

L-Profile 25/35/3 (Connection-Piece)

Nr. M 0 - 440

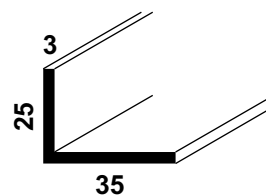

Code

05/L25/35/3 MC

Z-Profil 40/55/40/2 mm

Z-Profile 40/55/40/2 mm

System XLZ-h-100
Nr. S5443 - 758

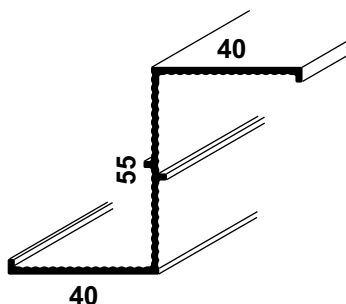

Code

05/Z40/55/40/2

Z-Profil 40/70/40/2 mm

Z-Profile 40/70/40/2 mm

System XLZ-h-100
Nr. S5325 - 837

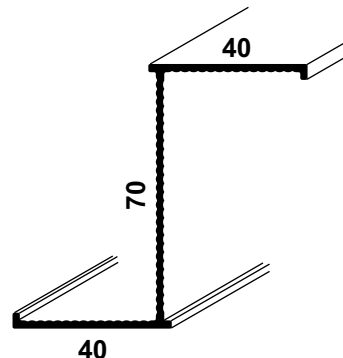

Code

05/Z40/70/40/2

Fensteranschlussprofil 6 mm

Window Connection-Profile

Nr. S4997 - 329

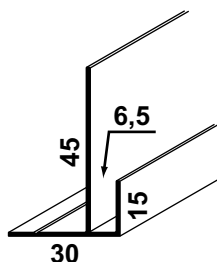

Code

05/FP30/6,5

Fensteranschlussprofil 8 mm

Window Connection-Profile

Nr. S4998 - 333

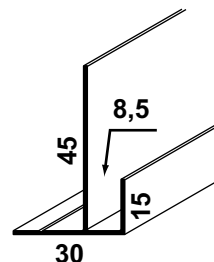

Code

05/FP30/8,5



Sonderprofile/Spezial-Profiles

Werkstoff/Material: Al Mg Si 0,5/F25, Länge/Fixlength 6000mm

Leibungsprofil Argeton
Special-Profile for Argeton
Nr. S 5082 - 617

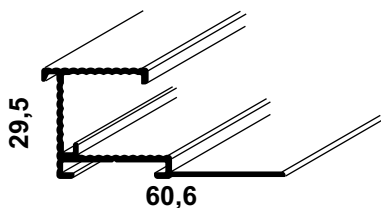

Code

05/Leib.pr.Argeton

Außeneckprofil für Argeton
Corner-Profile for Argeton
Nr. M 703 - 535

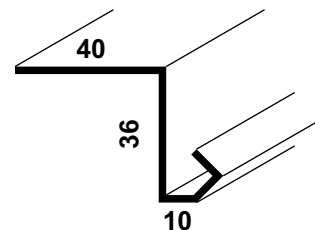

Code

05/AE40/36

Außeneckprofil für Argeton
Corner-Profile for Argeton
Nr. M 736 - 613

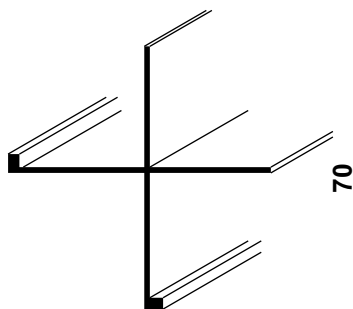

Code

05/AE70/70

Außeneckprofil für Argeton
Corner-Profile for Argeton
Nr. M 839 - 1236

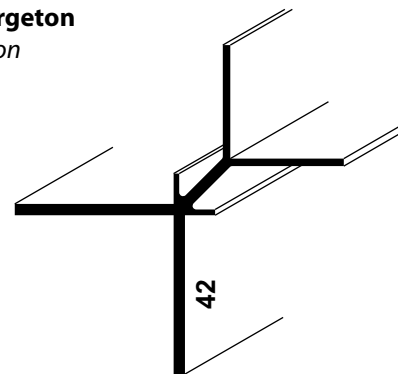

Code

05/AE81/81

Hutprofil KLE 30/30-40
Nr. S 1234 - 932

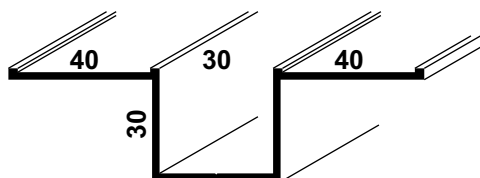

Code

05/Hut30/30-40

Hutprofil KLE 30/25/35/6 N
Nr. S 2036 - 756

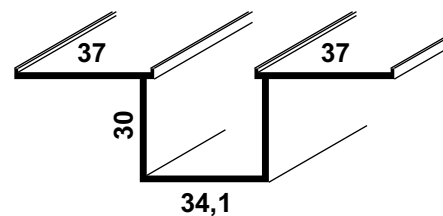

Code

05/Hut30/25/35



Sonderprofile/Spezial-Profiles

Werkstoff/Material: Al Mg Si 0,5/F25, Länge/Fixlength 6000mm

Stoßverbinder U27/30

Connection Profile U27/30

Nr. S2066-368

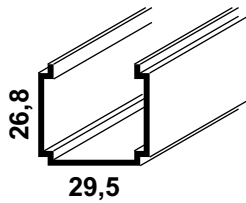

Code

05/U27/30

Hutprofil für Keramik mit Alu-Klammern

Hatprofile for ceramic with alu-clamps

Nr. M 559 - 522

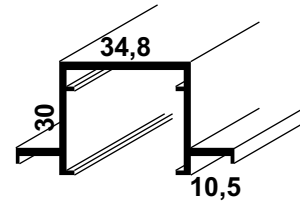

Code

05/HUT30/35/2M

L-Profil 40/40

Dicke 1,8 mm

L-Profile 40/40

Thickness 1,8 mm

Nr. S4884 - 321

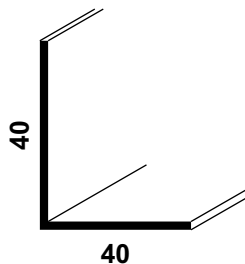

Code

05/L40/40/1,8N

T-Profil 40/80

Dicke 1,8 mm

T-Profile 40/80

Thickness 1,8 mm

Nr. S4885 - 486

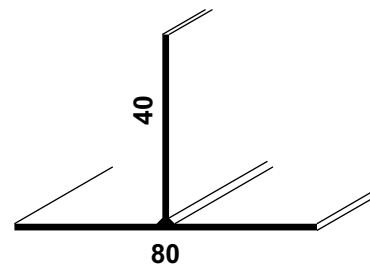

Code

05/T40/80/1,8N

TS300 Anfangsprofil

TS300 Starter Profile

Nr. K36242 - 643

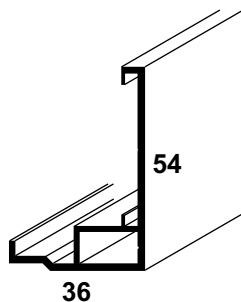

Code

05/TS300-AP

TS300 Hauptprofil

TS300 Main Support Profile

Nr. K36241 - 999

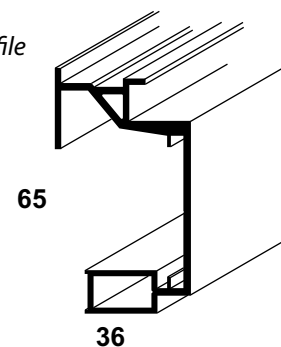

Code

05/TS300-HP



Verbindungs- und Befestigungsmittel / Fasteners and screws

Bohrschraube (SR2 und T20)/Self-Driven-Screw

Holzschraube/Woodscrew

SR2 - Schraubklingen/SR2 Bits

4,2/16 mm

4,2/25 mm

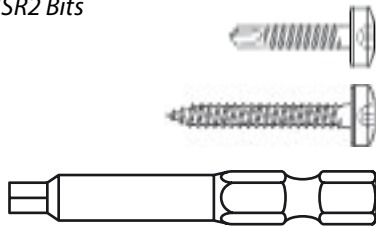

Code

04/16

04/25

04/SR2

Bohrschraube mit 6kt-Kopf

Self-Driven-Screw with hexagon head

6,0x36 mm/6,0x45 mm

4,8x19 mm

Nuss für Bohrschraube

Nut for Self-Driven-Screw

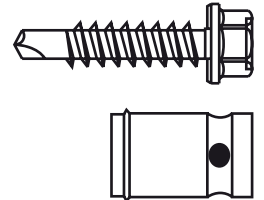

Code

04/JT3-X-2-6,0x36

04/JT3-X-2-6,0x46

04/4,8x19E-M

04/K-SW8-1/4x65

Dübel für Beton/Dowel for concrete

SDF-KB-10x60 V + Schraube/Screw

SDF-KB-10x80 V + Schraube/Screw

SDF-KB-10x100 V + Schraube/Screw

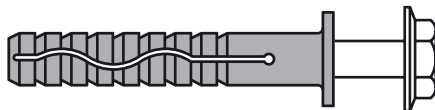

Code

06/SDF-10x60

06/SDF-10x80

06/SDF-10x100

Universaldübel/Universal Dowel

SDF-KB-10Ux80 V + Schraube/Screw

SDF-KB-10Ux100 V + Schraube/Screw

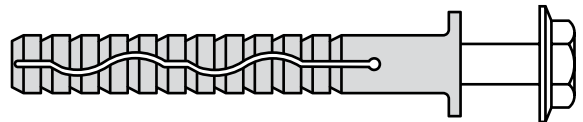

Code

06/SDF-10Ux80

06/SDF-10Ux100

Bolzenanker 8x10 mm in Edelstahl

Stainless steel dowel 8x10 mm

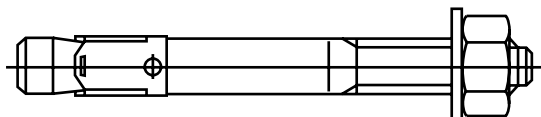

Code

06/BZ-8x10/75-E

Blindniet/Rivet Ø 5 mm

Längen/Length 10-18 mm

Kopf/Head Ø 9,5/14 mm

lackiert oder blank/coloured or raw

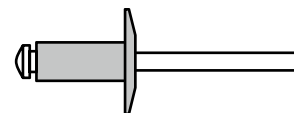

Code

11/5x10/9,5

11/5x16/14

11/5x18/14



Befestigungsmittel/Klebesystem/Fasteners/Adhesive system

EJOT PT-S 60 x 9,5
EJOT PT-S 60 x 11,5
EJOT PT-S 60 x 14,5

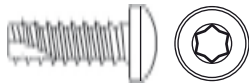

Code

13/EJTPTS60/9,5

13/EJTPTS60/11,5

13/EJTPTS60/14,5

KEIL-Anker A4/KEIL-Undercut Anchor A4

Setztiefe/Depth t=5,5/7 mm
 mit Schraube/Screw included



Code	Setztiefe / Depth
13/M6x10	t=5,5
13/M6x11,5	t=7
13/M6x17,5	t=5,5
13/M6x19	t=7

Sika-Cleaner 205
SikaTack-Panel Primer
 Dose à 1000 ml für ca. 300 m
 Tin à 1000 ml for approx. 300 m



Code

09/SC/1000

09/STPP/1000

SikaTack-Montageband/SikaTack Fixing Strip

Dicke 3 mm, Länge 13 m
 Thickness 3 mm, length 13 m

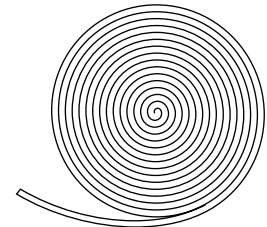

Code

09/STM/33

Handdruckpistole für Kartusche/Monoportion

Handgun for Cartridge/Monoportion

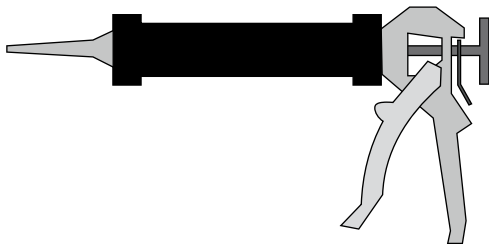

Code

09/HDP-Kart

09/HDP-Mopo

SikaTack-Panel Kartusche/Monoportion

Cartridge/Monoportion

à 310 ml/600 ml
 für ca. 7 lfm/14 lfm
 for approx. 7 m/14 m output



Code

09/STP/310

09/STP/600



Isolatoren/Insulators

Werkstoff/Material: Hart-PVC/Hard-PVC

Isolator M/Insulator M
Isolator für MacFOX Medium
Insulator for MacFOX Medium

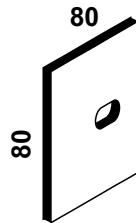

Code

10/Iso-M

Isolator L/Insulator L
Isolator für MacFOX Large
Insulator for MacFOX Large

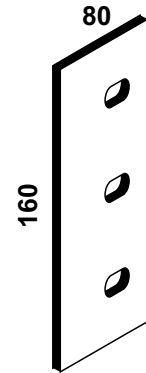

Code

10/Iso-L

Isolator MW/Insulator MW
Isolator für MacWUDI Medium
Insulator for MacWUDI Medium

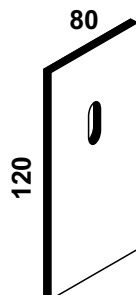

Code

10/Iso-L MW



ConFOX/DisFOX

Werkstoff/Material: Al Mg Si 0,5/F25

MacDISFOX M

Distanzstück Medium
Distance-Element Medium

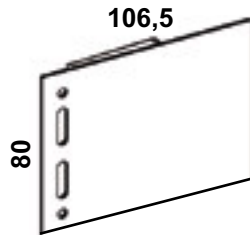

Code
17/MDF-80

MacDISFOX L

Distanzstück Large
Distance-Element Large

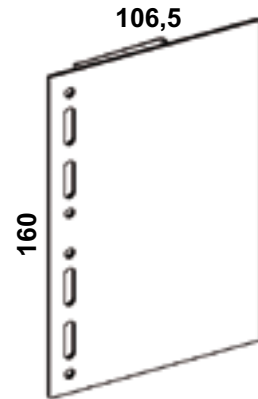

Code
17/MDF-160

MacCONFOX

Verbindungsstück
Connection-Element

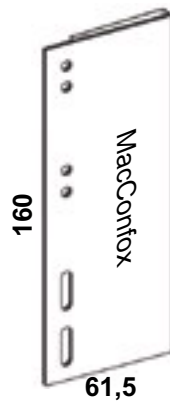

Code
17/MCF

Sonderkonsole für Deckenabhängung

Special T-Profile for ceiling
Nr. S4882 - 647

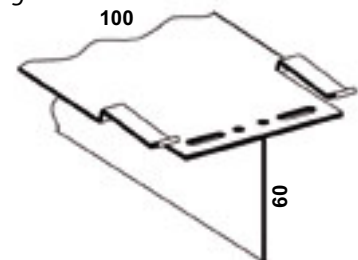

Code
17/T60/100/500



System

Keramik / Ceramic

MTC-v-100

Werkstoff/Material: Edelstahl/Stainless Steel

Mittelklammer für Keramikfassade

Middle-Clamp for ceramic facade

6-6,5 mm
9-10 mm
11-11,5 mm

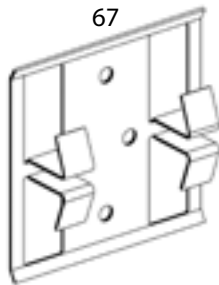

Code

07/KEM4-EK

Einzelklammer für Keramikfassade

Single-Clamp for ceramic facade

6-6,5 mm
9-10 mm
11-11,5 mm

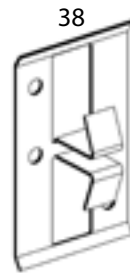

Code

07/KER-EK

Untere Randklammer für Keramikfassade

Bottom-Clamp for ceramic facade

6-6,5 mm
9-10 mm
11-11,5 mm

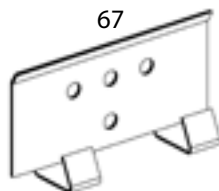

Code

07/KEU-EK

Untere Randklammer für Keramikfassade

Bottom-Clamp for ceramic facade

6-6,5 mm
9-10 mm
11-11,5 mm



Code

07/KEU1-EK



System

Keramik / Ceramic

XLC-h-320

Werkstoff/Material: Al Mg Si 0,5/F25, Länge/Fixlength 6000mm

Hutprofil/Hatprofile

Nr. S 2036 - 756

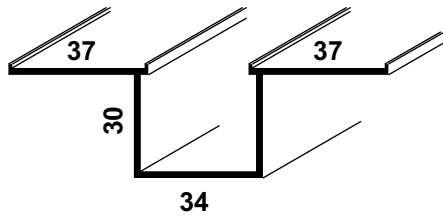

Code

05/Hut30/25/35

U-Profil 20/30/2 (Stoßverbinder)

U-Profile 20/30/2 (Connection-Piece)

Nr. 0 - 356

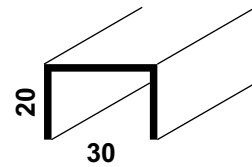

Code

05/U20/30/2 MC

Einzelklammer für Keramikfassade

Single-Clamp for ceramic facade

6-6,5 mm
9-10 mm
11-11,5 mm



Code

07/KER-EK

Untere Randklammer für Keramikfassade

Bottom-Clamp for ceramic facade

6-6,5 mm
9-10 mm
11-11,5 mm



Code

07/KEU1-EK



System

Keramik / Ceramic

MTC-v-200

Werkstoff/Material: Al Mg Si 0,5/F25, Länge/Fixlength 6000mm

T-Profil für Keramik mit Alu-Klammern

T-Profile for ceramic with alu-clamps

Nr. S4778 - 658

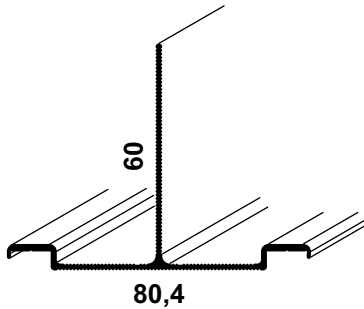

Code

05/KT80/60N

L-Profil für Keramik mit Alu-Klammern

L-Profile for ceramic with alu-clamps

Nr. S4779 - 458

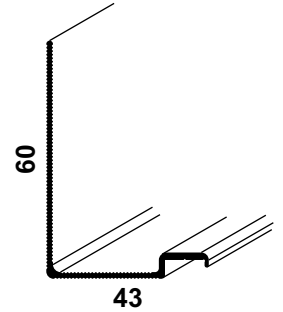

Code

05/KL40/60N

Eckprofil für Keramik mit Alu-Klammern

Corner-Profile for ceramic with alu-clamps

Nr. S4780 - 332

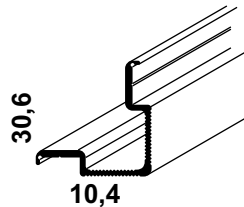

Code

05/KE30/30N

T-Klammer/T-Clamp

für Plattendicken/Thickness

8 - 9,5 mm

9,5 - 10,5 mm

Fuge ab 2,5 mm/Joint 2,5 mm up

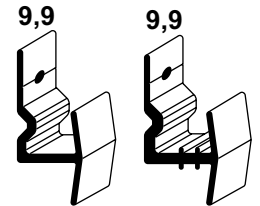

Code

07/KT9

07/KT11

07/KT11N

07/KT12N

Untere Randklammer/Bottom-Clamp

für Plattendicken/Thickness

8 - 9,5 mm

9,5 - 10,5 mm

12 mm

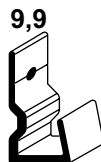

Code

07/KU9

07/KU11

07/KU12

Obere Randklammer/Top-Clamp

für Plattendicken/Thickness

8 - 9,5 mm

9,5 - 10,5 mm



Code

07/KO9

07/KO11



System

Keramik / Ceramic

XLC-h-330

Werkstoff/Material: Al Mg Si 0,5/F25, Länge/Fixlength 6000mm

Hutprofil für Keramik mit Alu-Klammern

Hatprofile for ceramic with alu-clamps

Nr. 14 - 575
Nr. M 559 - 522

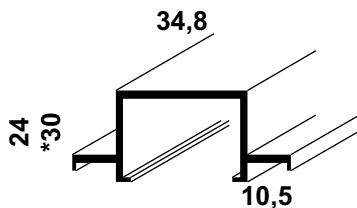

Code

05/HUT57/24

05/HUT30/35/2M

U-Profil 20/30/2 (Stoßverbinder)

U-Profile 20/30/2 (Connection-Piece)

Nr. 0 - 356

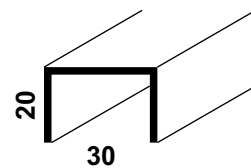

Code

05/U20/30/2 MC

Hut-Klammer/Hat-Clamp
für Plattendicken/Thickness
9-11 mm



Code

07/KH11-M

T-Klammer/T-Clamp
für Plattendicken/Thickness
8 - 9,5 mm
9,5 - 10,5 mm
Fuge ab 2,5 mm/Joint 2,5 mm up

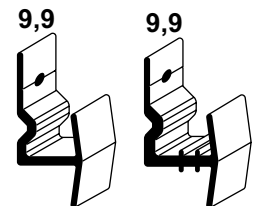

Code

07/KT9

07/KT11

07/KT11N

07/KT12N

Untere Randklammer/Bottom-Clamp
für Plattendicken/Thickness
8 - 9,5 mm
9,5 - 10,5 mm
12 mm

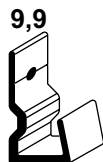

Code

07/KU9

07/KU11

07/KU12

Obere Randklammer/Top-Clamp
für Plattendicken/Thickness
8 - 9,5 mm
9,5 - 10,5 mm

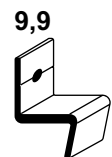

Code

07/KO9

07/KO11



System

Keramik / Ceramic

MTC-v-350

Werkstoff/Material: Al Mg Si 0,5/F25, Länge/Fixlength 6000mm

T-Profil 60/80

T-Profile 60/80
Nr. S4795 - 735

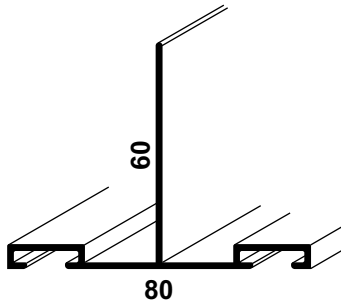

Code

05/KT60/80/E-N

L-Profil 60/40

L-Profile 60/40
Nr. S4796 - 485

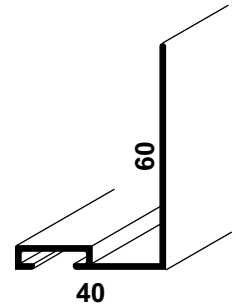

Code

05/KL60/40E-N

Eckprofil 30/30

Corner-Profile 30/30
Nr. S4797 - 402

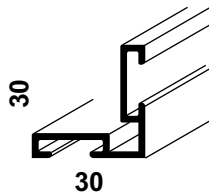

Code

05/KE30/30/E-N

T-Klammer/T-Clamp

für Plattendicken/Thickness
8,5 - 12,5 mm (stainless steel)
12 - 14 mm (Alu)

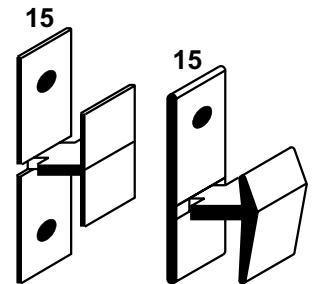

Code

07/KT10,5/15 E

07/KT12,5/15 E

07/KT14/15

Untere Randklammer/Bottom-Clamp

für Plattendicken/Thickness
8,5 - 12,5 mm (stainless steel)
12 - 14 mm (Alu)

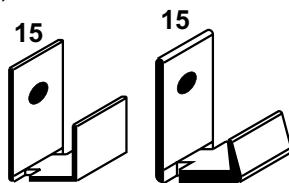

Code

07/KU10,5/15 E

07/KU12,5/15 E

07/KU14/15

Obere Randklammer/Top-Clamp

für Plattendicken/Thickness
8,5 - 12,5 mm (stainless steel)
12 - 14 mm (Alu)

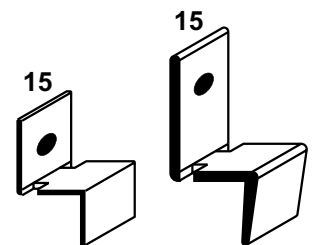

Code

07/KO10,5/15 E

07/KO12,5/15 E

07/KO14/15



System

Keramik / Ceramic

XLC-h-350

Werkstoff/Material: Al Mg Si 0,5/F25, Länge/Fixlength 6000mm

Hutprofil/Hatprofile

Nr. S4715 - 593

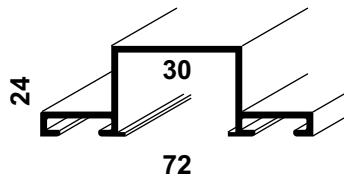

Code

05/HUT24/72/E-N

U-Profil 20/30/2 (Stoßverbinder)

U-Profile 20/30/2 (Connection-Piece)

Nr. 0 - 356

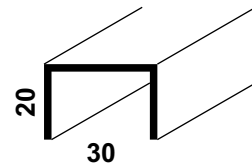

Code

05/U20/30/2 MC

Eckprofil 30/30

Corner-Profile 30/30

Nr. S4797 - 402

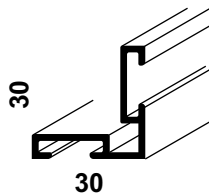

Code

05/KE30/30/E-N

T-Klammer/T-Clamp

für Plattendicken/Thickness

8,5 - 12,5 mm (stainless steel)

12 - 14 mm (Alu)

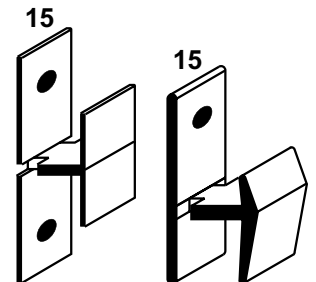

Code

07/KT10,5/15 E

07/KT12,5/15 E

07/KT14/15

Untere Randklammer/Bottom-Clamp

für Plattendicken/Thickness

8,5 - 12,5 mm (stainless steel)

12 - 14 mm (Alu)

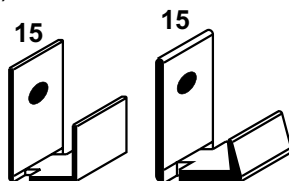

Code

07/KU10,5/15 E

07/KU12,5/15 E

07/KU14/15

Obere Randklammer/Top-Clamp

für Plattendicken/Thickness

8,5 - 12,5 mm (stainless steel)

12 - 14 mm (Alu)

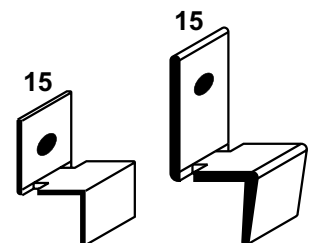

Code

07/KO10,5/15 E

07/KO12,5/15 E

07/KO14/15



Artikelliste/Partlist

System

MLV/k-v-20

Werkstoff/Material: Al Mg Si 0,5/F25, Länge/Fixlength 6000m

Keramik / Ceramic
Faserzement / Fibrecement
HPL

U-Profil 11,5/45/2

U-Profile 11,5/45/2

Nr. S4802 - 343

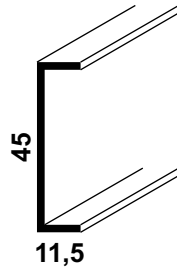

Code

05/U11,5/45/2N

Agraffenprofil 60mm

Hanger-Profile 60mm

Nr. S5000 - 516

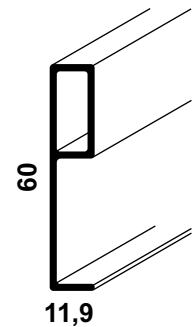

Code

05/CX-60 N

Agraffe 40mm/Hanger 40mm

starr oder justierbar/fix or adjustable

6-kant für Keil/6-edge hole for Keil

Nr. S4803

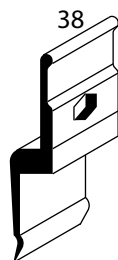

Code

13/ASK/40

13/AJK/40

Agraffe starr 25/40/50 mm/6,5 mm Loch

Hanger fix 25/40/50 mm/6,5 mm hole

Nr. S4803

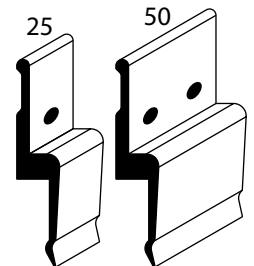

Code

13/AS25/11,5-1RL

13/AS40/11,5-1RL

13/AS50/11,5-2RL

Agraffe justierbar 25/40/50 mm

6,5x2x6,5 mm Loch + M6

Levelling Hanger 6,5/2x6,5 mm,

M6 thread

Nr. S4803

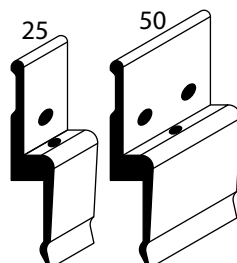

Code

13/AJ25/11,5-1RL

13/AJ40/11,5-1RL

13/AJ50/11,5-2RL

Justierschraube 6x40 A2/Adjusting Screw

Zylinderkopf/Cylinder-Head

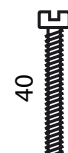

Code

13/JS



www.eurofox.com

Artikelliste/Partlist

System

MLZ/k-v-00

Werkstoff/Material: Al Mg Si 0,5/F25, Länge/Fixlength 6000mm

Keramik / Ceramic
Faserzement / Fibrecement
HPL

Agraffen-Tragprofil/Hanger-Profile

Nr. S5058 - 663

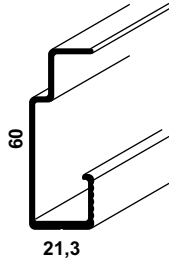

Code

05/A/Tragprofil

Justierschraube 6x40 A2/Adjusting Screw

Zylinderkopf/Cylinder-Head



Code

13/JS

Agraffe starr 40/50 mm/6,5 mm Loch

Hanger fix 40/50 mm/6,5 mm hole

Nr. S5059 - 705

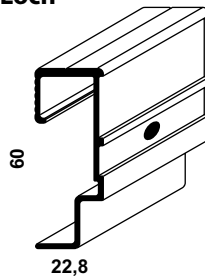

Code

13/AS40-1RL

13/AS40-2RL

13/AS50-2RL

Agraffe justierbar 40/50 mm/6,5 mm Loch

Levelling Hanger 40/50 mm/6,5 mm hole

Nr. S5059 - 705

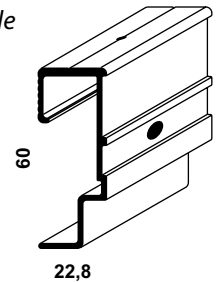

Code

13/AJ 40-1RL

13/AJ 40-2RL

13/AJ 50-2RL

Agraffe Tergo starr 40 mm/10,4 mm 4-kant Loch

Tergo Hanger fix 40 mm/10,4 mm 4-edge hole

Nr. S5059 - 705

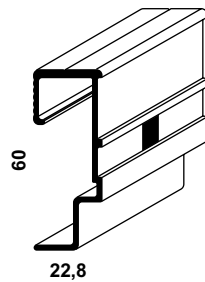

Code

13/AST 40

Agraffe Tergo just. 40 mm/10,4 mm 4-kant Loch + M6

Tergo Levelling Hanger 40 mm/10,4 mm 4-edge hole + M6

Nr. S5059 - 705

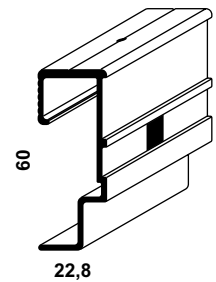

Code

13/AJT 40



www.eurofox.com

Artikelliste/Partlist

System

XLP-v-300

Werkstoff/Material: Al Mg Si 0,5/F25, Länge/Fixlength 6000mm

Keramic / Ceramic
Faserzement / HPL / Fibrecement / HPL
Naturstein / Natural Stone
Glas / Glass

Horizontalprofil f. XLP-300

Special-Profile XLP-300
Nr. S 5196 - 772

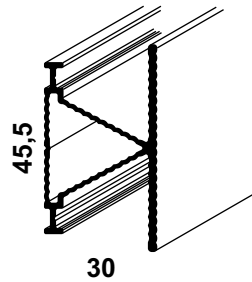

Code

21/Tragprofil XLP-300

Halter für XLP-300 Tragprofil

Clip for XLP-300 Special-Profile
Nr. S 4978 - 541

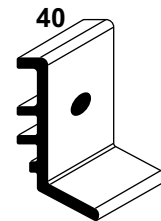

Code

18/Clips

Plattentragprofil 25/20mm

Special-Profile for tiles
Nr. S 5088 - 536
Nr. S 5180 - 446

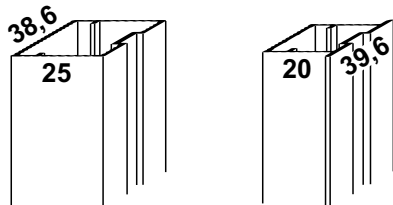

Code

21/Plattentragprofil

21/Pl.-Tragprofil

Stoßverbinder für XLP-Tragprofil

Connection-Element for XLP-Profile
Nr. S 4904 - 314

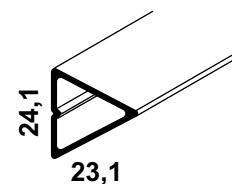

Code

18/Stoßverbinder

Haken/Hook

Breite/Width 35 mm
Nr. S 5087 - 1013

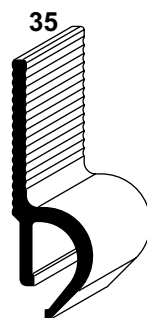

Code

21/Haken-35

Agraffenhalter/Hook

Breite/Width 26 mm
Nr. S 5197 - 718

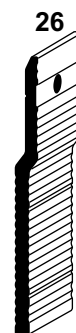

Code

21/Agraffenhalter



www.eurofox.com

Artikelliste/Partlist

System

XTS-v-400

Werkstoff/Material: Al Mg Si 0,5/F25, Länge/Fixlength 6000mm

Keramik / Ceramic
Ziegel / Terracotta
(Piterak, NBK, Longoton)

T-Profil 60/120/T-Profile 60/120

Nr. S5032 - 1021

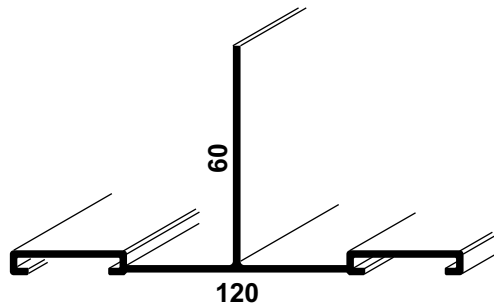

Code

05/KT60/120N

L-Profil 60/60/L-Profile 60/60

Nr. S5033 - 625

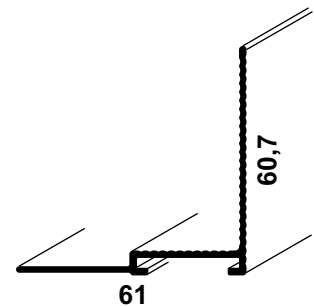

Code

05/KL60/60N

Fugenprofil für Ziegel

Joint-Profile for Terracotta

Material: AlMgSi0,5/F13

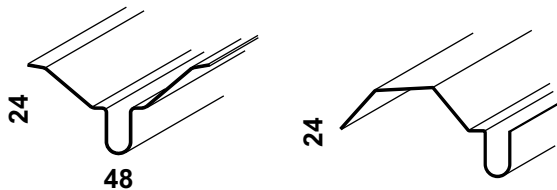

Code

05/FP Ziegel W

05/FP Ziegel halb W

T-Klammer/T-Clamp

Ausladung/Depth

12 - 17 mm

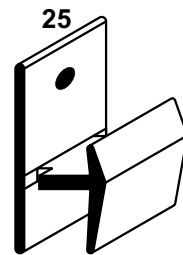

Code

07/KT14/25

07/KT17/25

Untere Randklammer/Bottom-Clamp

Ausladung/Depth

12 - 17 mm

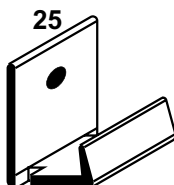

Code

07/KU14/25

07/KU17/25

Obere Randklammer/Top-Clamp

Ausladung/Depth

12 - 17 mm

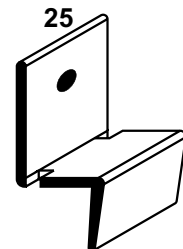

Code

07/KO14/25

07/KO17/25



www.eurofox.com

Artikelliste/Partlist

System

XLS-h-330

Werkstoff/Material: Al Mg Si 0,5/F25, Länge/Fixlength 6000mm

Keramik / Ceramic
Ziegel / Terracotta
(Piterak, NBK, Longoton)

Hutprofil Argeton

Hatprofile Argeton

Nr. S 5081 - 1035

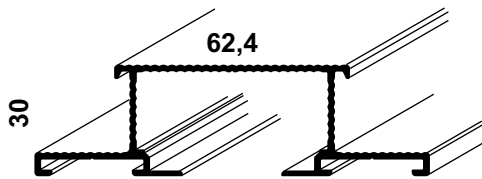

Code

05/Hutprofil Argeton

Z-Profil 60/30

Z-Profile 60/30

Nr. S4748 - 623

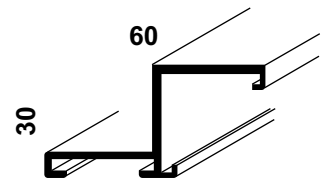

Code

05/Z60/30 N

Halter für Hutprofil

Clip for Omega-Profile

Nr. S5083 - 478

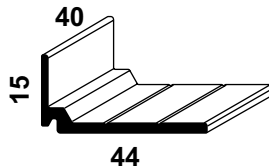

Code

05/Halter f. Hutprofil

T-Klammer/T-Clamp

Ausladung/Depth

12 - 17 mm

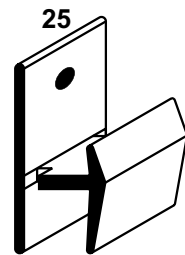

Code

07/KT14/25

07/KT17/25

Untere Randklammer/Bottom-Clamp

Ausladung/Depth

12 - 17 mm

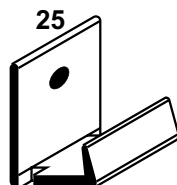

Code

07/KU14/25

07/KU17/25

Obere Randklammer/Top-Clamp

Ausladung/Depth

12 - 17 mm

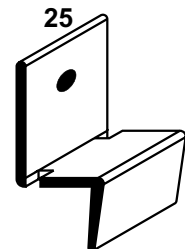

Code

07/KO14/25

07/KO17/25



www.eurofox.com

System

XLP-v-400

Werkstoff/Material: Al Mg Si 0,5/F25, Länge/Fixlength 6000mm

Ziegel / Terracotta
(Argeton / Alphonon)

Tragprofil f. XLP-400

Special-Profile for XLP-400
Nr. S 5387 - 592

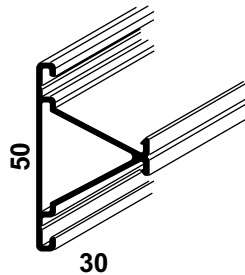

Code

18/Tragprofil

Halter für XLP-400 Tragprofil

Clip for XLP-400 Special-Profile
Nr. S 4978 - 541

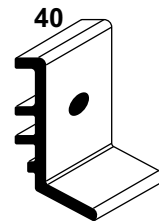

Code

18/Clips

M-Halter für XLP-400

Middle-Clamp for XLP-400
Nr. S 5218 - 715

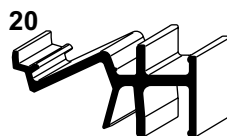

Code

18/M-Halter

Stoßverbinder für XLP-Tragprofil

Connection-Element for XLP-Profile
Nr. S 4904 - 314

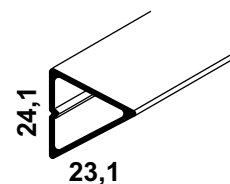

Code

18/Stoßverbinder

O-Halter für XLP-400

Top-Clamp for XLP-400
Nr. S 5217 - 656

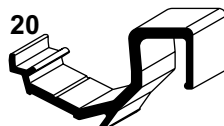

Code

18/O-Halter

U-Halter für XLP-400

Bottom-Clamp for XLP-400
Nr. S 5216 - 892

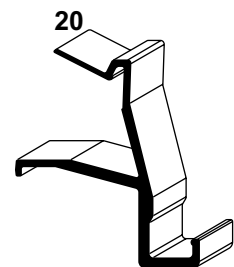

Code

18/U-Halter



Artikelliste/Partlist

System

XTS-v-300

Werkstoff/Material: Al Mg Si 0,5/F25, Länge/Fixlength 6000mm

Ziegel / Terracotta
(Argeton / Alphaton)

T-Profil 60/120/T-Profile 60/120

Nr. S5032 - 1021

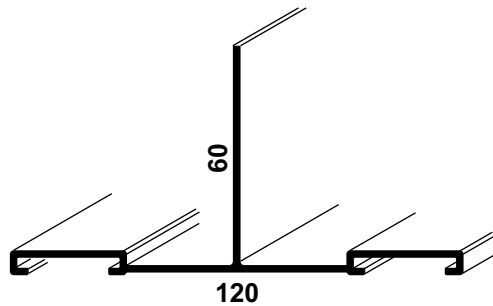

Code

05/KT60/120N

L-Profil 60/60/L-Profile 60/60

Nr. S5033 - 625

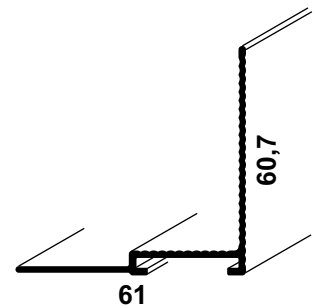

Code

05/KL60/60N

Fugenprofil für Ziegel

Joint-Profile for Terracotta

Material: AlMgSi0,5/F13

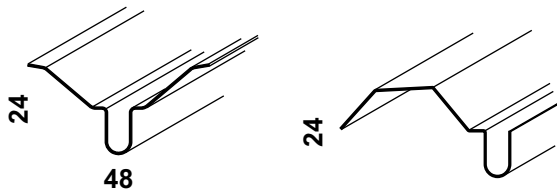

Code

05/FP Ziegel W

05/FP Ziegel halb W

O-Halter/Top-Clamp

RAL 8004 kupferbraun/copper brown

RAL 1015 elfenbein/ivory

RAL 7005 mausgrau/mouse grey

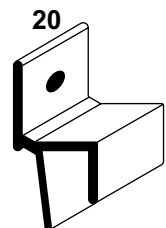

Code

16/O8004

16/O1015

16/O7005

M-Halter/Middle-Clamp

RAL 8004 kupferbraun/copper brown

RAL 1015 elfenbein/ivory

RAL 7005 mausgrau/mouse grey

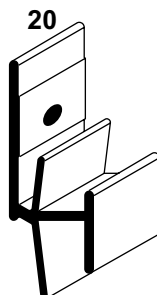

Code

16/M8004

16/M1015

16/M7005

U-Halter/Bottom-Clamp

RAL 8004 kupferbraun/copper brown

RAL 1015 elfenbein/ivory

RAL 7005 mausgrau/mouse grey

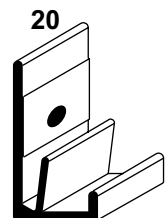

Code

16/U8004

16/U1015

16/U7005



www.eurofox.com

System

XLS-h-300

Werkstoff/Material: Al Mg Si 0,5/F25, Länge/Fixlength 6000mm

Ziegel / Terracotta
(Argeton / Alphonon)

Hutprofil Argeton

Hatprofile Argeton

Nr. S 5081 - 1035

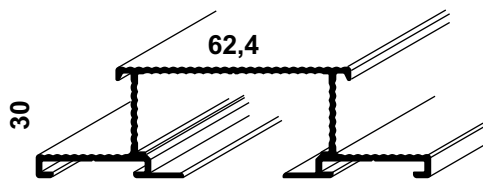

Code

05/Hutprofil Argeton

Z-Profil 60/30

Z-Profile 60/30

Nr. S4748 - 623

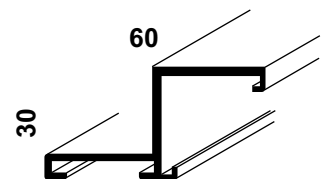

Code

05/Z60/30 N

Halter für Hutprofil

Clip for Omega-Profile

Nr. S5083 - 478

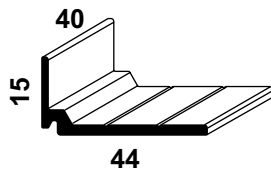

Code

05/Halter f. Hutprofil

O-Halter/Top-Clamp

RAL 8004 kupferbraun/copper brown

RAL 1015 elfenbein/ivory

RAL 7005 mausgrau/mouse grey

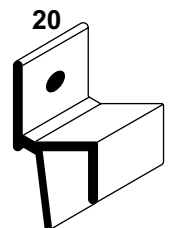

Code

16/O8004

16/O1015

16/O7005

M-Halter/Middle-Clamp

RAL 8004 kupferbraun/copper brown

RAL 1015 elfenbein/ivory

RAL 7005 mausgrau/mouse grey

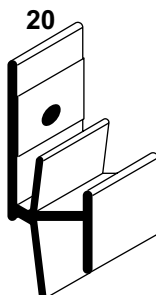

Code

16/M8004

16/M1015

16/M7005

U-Halter/Bottom-Clamp

RAL 8004 kupferbraun/copper brown

RAL 1015 elfenbein/ivory

RAL 7005 mausgrau/mouse grey

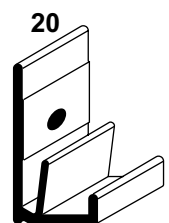

Code

16/U8004

16/U1015

16/U7005



System

Ziegel / Terracotta
(Zephir / Facing Tile)

XLT-v-100, XLT-v-200

Werkstoff/Material: Al Mg Si 0,5/F25, Länge/Fixlength 6000mm

Tragprofil f. XLT-100 (Zephir)

Special-Profile for XLT-100

Nr. S 5227 - 611

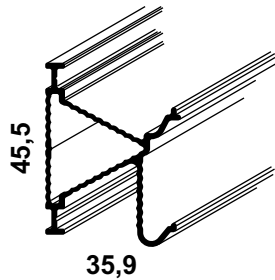

Code

05/Zephir

Tragprofil f. XLT-200 (Facing Tile)

Special-Profile for XLT-100

Nr. S 5226 - 658

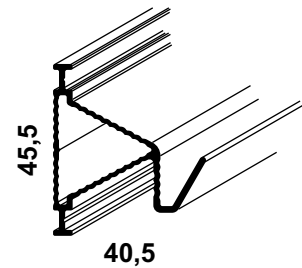

Code

05/Facing Tile

Halter für XLT Tragprofile

Clip for XLT Special-Profiles

Nr. S 4978 - 541

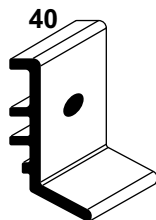

Code

18/Clips

Stoßverbinder für XLT-Tragprofile

Connection-Element for XLT-Profiles

Nr. S 4904 - 314

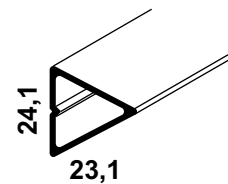

Code

18/Stoßverbinder



Artikelliste/Partlist

System

Autan/Shamal Sunscreens

Werkstoff/Material: Al Mg Si 0,5/F25

Autan-Halter 45°/Autan-Clip 45°

Breite/Width 50/100 mm

Nr. S5303 - 1024

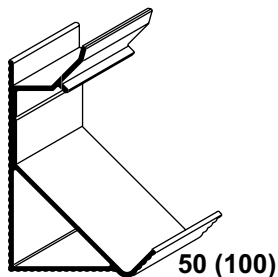

Code

23/A-Halter45/50

23/A-Halter45/100

Autan-Halter 90°-S/Autan-Clip 90°-S

Breite/Width 50/100 mm

Nr. S5302 - 1504

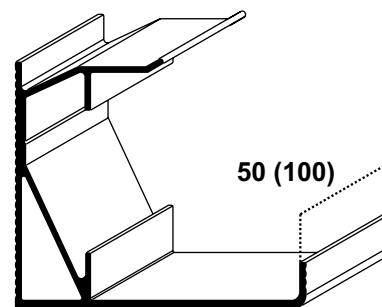

Code

23/A-Halter90/50S

23/A-Halter90/100S

Shamal-Halter 15°/Shamal-Clip 15°

Breite/Width 100 mm

Nr. S6056 - 2905

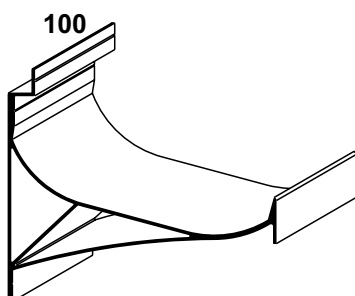

Code

23/SH 14/15°/100

Autan-Halter 90°/Autan-Clip 90°

Breite/Width 50/100 mm

Nr. S5656 - 1262

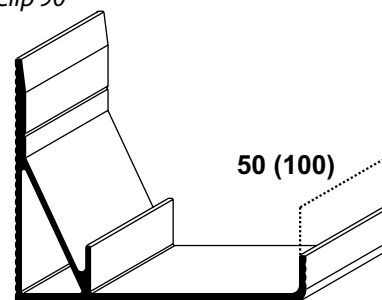

Code

23/A-Halter90/50

23/A-Halter90/100

Rundrohr/Special-Tube

Ø 20 mm

Nr. S5618 - 504

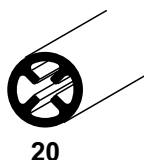

Code

23/Rohr20

Abschlussklammer/End-Clamp

Nr. S5292 - 707

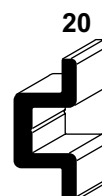

Code

23/A-End-clamp



www.eurofox.com

System

MUK-v-a-100

Werkstoff/Material: Al Mg Si 0,5/F25, Länge/Fixlength 6000mm

Compound / ACM

(Alucobond, Reynobond, Etalbond)

Kassetten-Profil mit Steg

Special Cassette-Profile

Nr. S 4901 - 1243

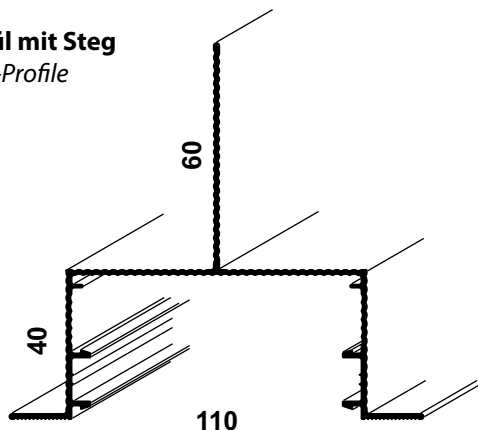

Code

05/K80/40S-N

Kassetten-Profil 80/40

Cassette-Profile 80/40

Nr. S4902 - 970

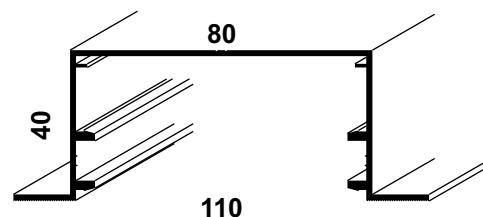

Code

05/K80/40-N

Einhangclip für 3 mm Kassetten

Clip for 3 mm cassettes



Code

14/KS-Clip

Clip für Kassetten-Fassade

Clip for cassette facade

Nr. S 5988 - 249

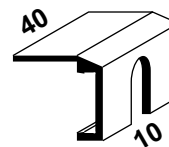

Code

14/CA-M

Alubolzen für Kassetten-Fassade

Alu-Bolt for cassette facade

Werkstoff/Material: Aluminium

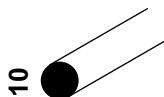

Code

14/BA



www.eurofox.com

System

MTA-v-400, MYH-v-900

Werkstoff/Material: Al Mg Si 0,5/F25, Länge/Fixlength 6000mm

Compound / ACM

(Alucobond, Reynobond, Etalbond)

T-Profil 60/120/1,9

T-Profile 60/120/1,9

Nr. S4886 - 811

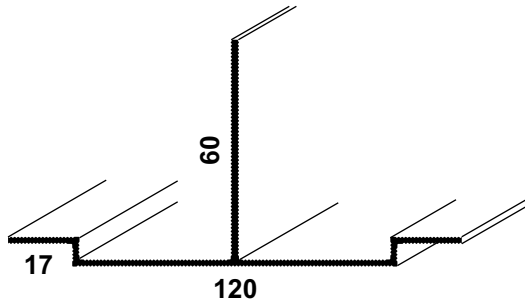

Code

05/T60/120/1,9N-A

U-Profil 80/30/2,5

U-Profile 80/30/2,5

Nr. S4887 - 809

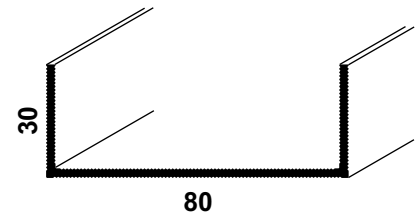

Code

05/U80/30/2,5 N

Abdeckprofil

Cover-Profile

Nr. M 755 - 605

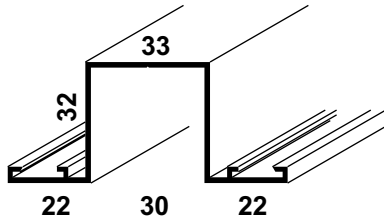

Code

05/A75/30/30

Y-Profil

Y-Profile

Nr. M 756 - 830

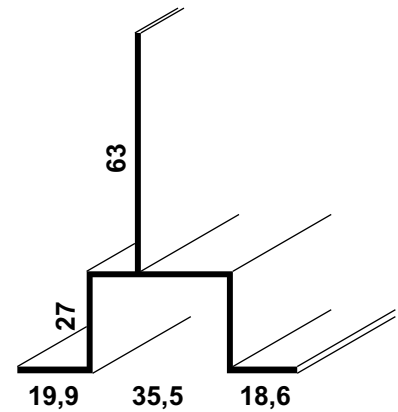

Code

05/Y60/35/27

